

Rugged Computing

-- rugged tablet pc

Your Best Assistant in
Challenging Environments

2010/0727

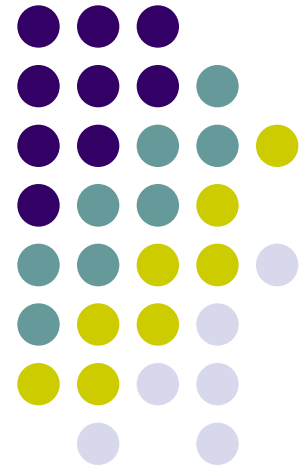

Agenda



- **Winmate Rugged Tablet PC Introduction**
- **What for? Diverse Applications**
- **Product Features-Pick up your own model**
- **Add-on Value**
- **Accessory**



Rugged Computing Overview

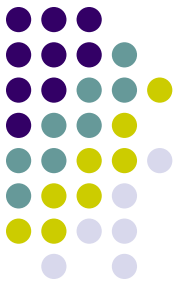

◆ Rugged Tablet PC Series

- ◆ Ruggedness, mobility, fan-less and battery solutions

◆ Marine Grade Series

- ◆ Marine Display/ Marine PC/ EAC Box

◆ G-WIN Series

- ◆ Fully ruggedized design/ low power platform/ sunlight readable

◆ Military Rack PC

- ◆ Robust PC design for harsh environment

◆ Full IP65 Box PC

- ◆ Box PC designed specifically for wet and dusty environments



Product Platforms



Platform

8.4"

10.4"

12.1"

**VIA C7M 1.2 GHz
VIA VX700**



N/A

R10V28M-

***UL Medical
Certificate**



By request

**Atom N270 1.6GHz
945GSE/ICH7M**



R08IA8M-

***UL Medical
Certificate**

***low power**



R10IA8M-

***low power**

R12IA8M-

***low power**

**Atom Z530 1.6GHz
Intel US15W**



R08I98M-

***Ultra low power**

N/A

N/A

**Core 2 Duo 1.06GHz U7500
945GME/ICH7M**



R08I88M- (new)

***High performance**

R10I88M-

***High performance**

R12I88M-

***High performance**

Product Information

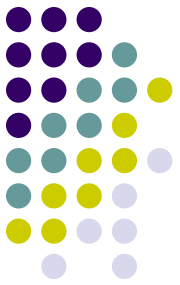

8.4"



10.4"



12.1"

	8.4"	10.4"	12.1"
Resolution	800 x 600	800 x 600 1024 x 768	1024 x 768
Touch	AMT 4-Wire 90% Transmittance	AMT 4-Wire	AMT 4-Wire
TR Touch	Optional	Optional	Optional
LED Panel	▼	▼	▼

Multi-Expansion for Universal Applications

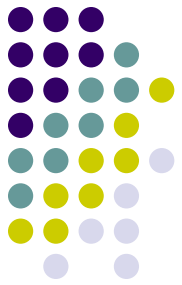

GPS integrated

Vehicle Examination

**3G/WWAN
GPRS card**



Outdoor Application

Sunlight Readable
IP54

Bluetooth Class B,
up to 100m/ CANBUS

Express Card /
PCMCIA



IEEE1394



1D/2D
Barcode Reader

IrDA Integrated

Logistics



MIL 810F Std

UL60601-1
Medical Cert.

Military

Ambulance



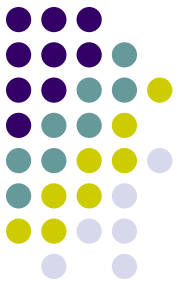

Rugged Tablet PC's Diverse Applications

- Equipped with everything needed for automation

- Vehicle Maintenance
- Medical Institution
- Geography Info. (GIS)
- Heavy Duty Transportation
- Warehousing & Storage
- Industrial
- Police
- Logistics
- Instrument Test
- Construction
- Military
- Outdoor Mechanic



Military application solutions



- MIL-STD-810F Temp/ Shock/ Vibration/ Drop tested
- Full IP54 protection
- Sunlight readable touch option



Police / Maintenance car solutions



- MIL-STD-810F Temp/ Shock/ Vibration/ Drop tested
- Wireless/ 3G communication
- Sunlight readable touch option
- Docking solution available

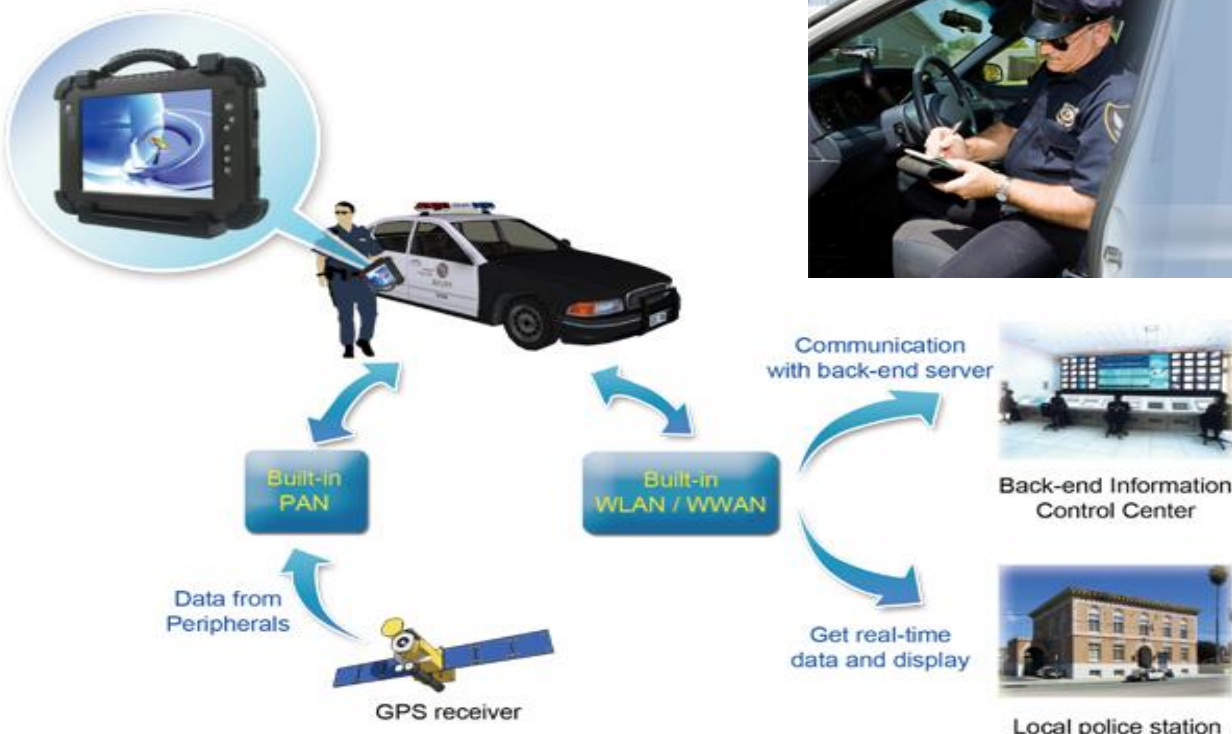

Heavy Duty/ Truck solutions



- MIL-STD-810F Temp/ Shock/ Vibration/ Drop tested
- Wireless/ 3G communication
- GPS built-in



Logistics solutions



Rugged Tablet PC in Warehousing Flow -enhance efficiency and reliability

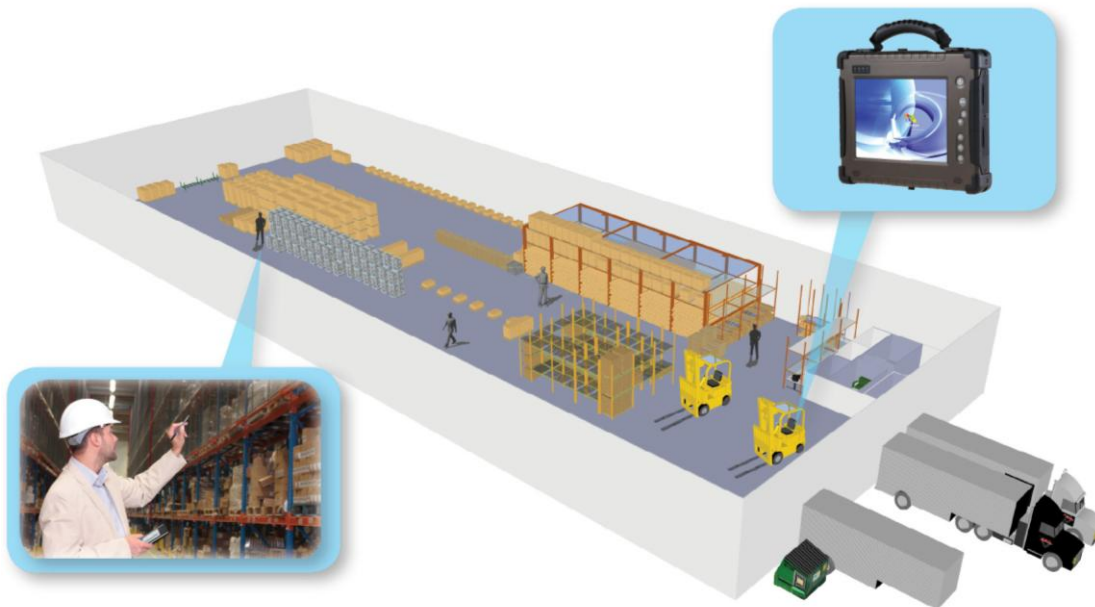

- MIL-STD-810F Temp/ Shock/ Vibration/ Drop tested
- wireless/ 3G communication
- RS232, USB available for external bar-code scanner, RFID reader

Medical solutions

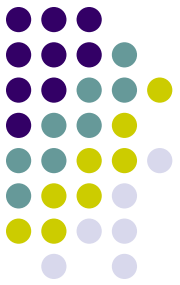

- **UL-60601-1 certified**
- **Programmable Hot-keys and hot tab**
- **Docking solution available**

Winmate®
Winmate Rugged Tablet PC
in Hospital

Barcode Reader

Pulsimeter

Blood pressure gauge

and more external devices

Education solutions



- 10.1” 1024x 600 with touch and Atom N270 platform
- light-weighted plastic housing
- wireless communication
- 4 hours battery operation
- Teaching/ Presentation software – NX Board available as option

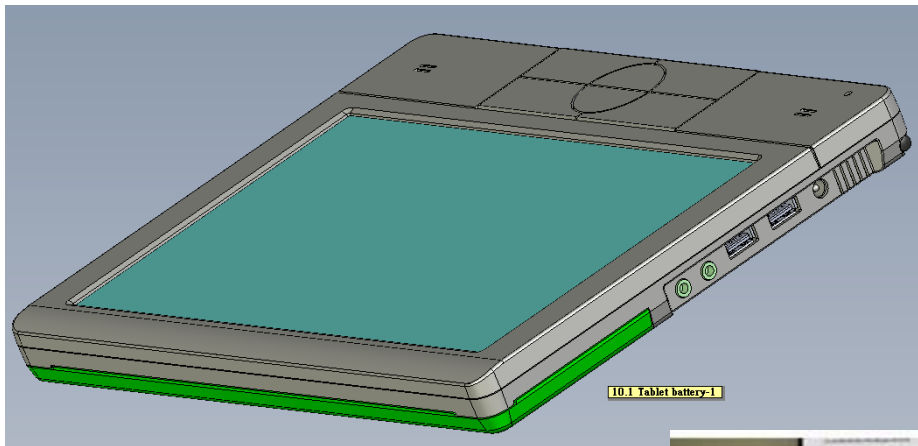

8.4" rugged tablet pc Profile

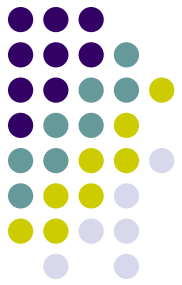

R081A8T-RTU1

Intel Atom N270 1.6GHz

R08198T-RTU1

Intel Atom Z530 1.6GHz

TOP View



USB

SD card port
(SD card reader)

Express card slot

Lying View

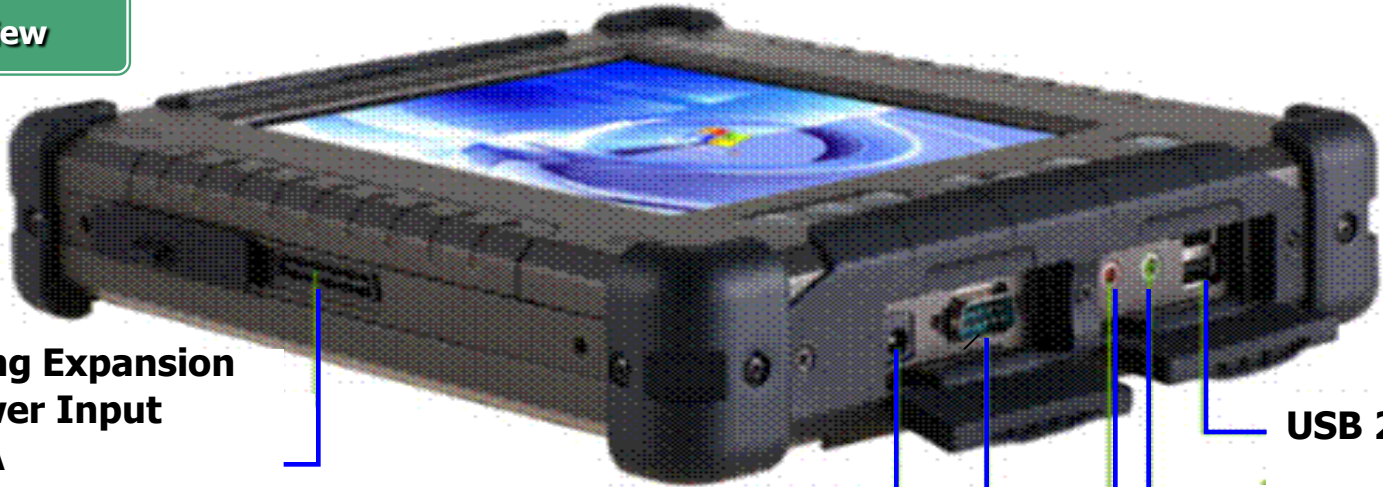

Docking Expansion
1xPower Input
1xVGA
1xLAN
4xUSB 2.0

Power Input

RS232

USB 2.0

Audio-out

Micro-in

10.4" rugged tablet pc Profile



R10V28T-RTXX

VIA C7M 1.2GHz

R10IA8T-RTXX

Intel Atom N270 1.6GHz

R10I88T-RTXX

Intel Core2Duo 1.06GHz

TOP View

PCMCIA
card slot

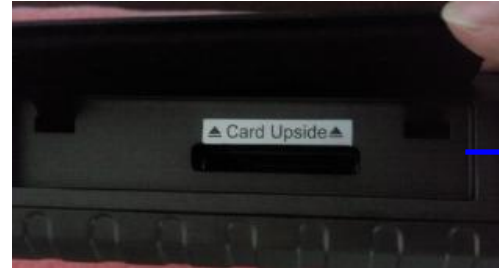

Express
card slot

Other Angles

LAN
Audio Out
Micro In
USB 2.0
Power Input



Docking Expansion
1xPower Input
4xUSB 2.0



12.1" rugged tablet pc Profile



R12IA8T-RTXX

Intel Atom N270 1.6GHz

R12I88T-RTXX

Intel Core2Duo 1.06GHz

TOP View

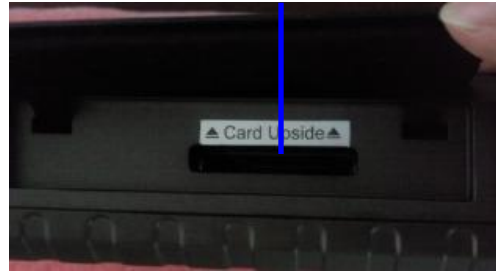

Express card slot

Other Angles

- LAN
- Audio Out
- Micro In
- USB 2.0
- Power Input



Docking Expansion for
1x Power Input, 4x USB 2.0



Docking Expansion
1x Power Input
4x USB 2.0

Platform Comparison

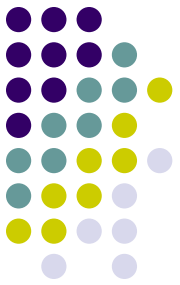

Platform Choices- Long Power Consumption or High Performance

Performance & Power Consumption Comparison

Plat Form	VIA Nano 1.2GHz VX700	Celeron M 1.0GHz 855GME	Atom N270 1.6GHz 945GSE
CPU	759	1156	1214
Graphic	182	350	522
Overall	688	905	1167
TDP	10W	12W	8W

Performance
increase
30%~40%

Power
Saving
Over 20%

Order Information:

- Intel Atom N270 1.6GHz-RxxIA8T-RTxx
- Intel Atom Z530 1.6GHz-R08I98T-RTU1

Features:

- Better performance and lower power consumption than conventional Intel Celeron M 1.0GHz
- Full size of IA8T from 8.4~12.1
- Battery sustains to 4hrs of IA8T, over 7hrs with I98T

PERFORMANCE	Winmate I980	Winmate V280	Panasonic CF-H1	GETAC E100
CPU	Atom Z530P	VIA C7M	Atom Z540	Intel A110Core
CPU Clock Speed	1.6GHz	1.2GHz	1.86GHz	800MHz
Thermal Design Power	2.3 watts	5.0 watts	2.4 watts	3.0 watts
CPU Mark	328.7	137.3	275.4	207.2
2D Graphics Mark	187.9	174.0	115.7	119.8
Memory Mark	209.1	124.1	242.7	155.5
Disk Mark	151.1	305.1	284.8	200.2
3D Graphics Mark	38.5	38.8	10.1	63.1
Overall PassMark	194.1	149.4	191.9	148.3



Comparison Table With Peered Levels-
from **Rugged Tablet Review**

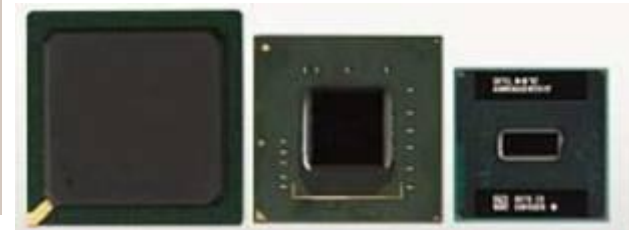

Product Features – Default Specification

Designed for vast majority needs!



- RAM:1GB, HDD: 80GB(min.) or **optional SSD**
- OS: Windows XP Embedded or **optional WES7**
- **Linux/ WinCE 6.0 BSP ready to support**
- Communication: Wi-Fi, Bluetooth (default)
- Expansion Slot: Express Card 34mm , USB , RS232
- Programmable Hotkey
- **LED Backlight Display (low power!)**
- Slim Carrying Bag
- Power Adapter
- Battery
- 4W Touch (Default)/ TR Touch (opt.)



Features -- Optional Communication Interface

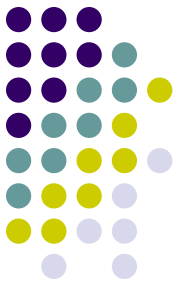

IrDA (customized)

- infrared
- Short distance

Compatibility with specific Baud Rate

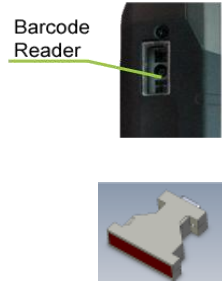

3G / WWAN (add-on card)

- 3.5G WCDMA/HSDPA
- 3G / GSM / UMTS



Mobile-broadband internet connectivity

GPS (built-in)

- Internal GPS Module
- USB Interface

Reliable positioning
Navigation Timing services



Barcode Scanner (customized)

- 1D/2D Barcode Module
- USB Interface



Data Capture
Barcode Scanner



Easy tools for operations



- **No Keyboard/Mouse-**

Using "HotTab" to replace the inconvenience of carrying keyboard / mouse



- **Reliability- Data Conservation by**

Reliable Protective Storage Cover



- **Hot Swappable Battery!! (Opt.)**

- Expands Operation Time without shutting down PC (for IA8, I98, I88 platform)

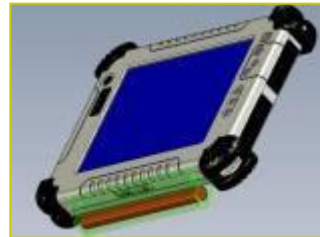

- **WebCam (optional)- 1.3Mega Pixel**

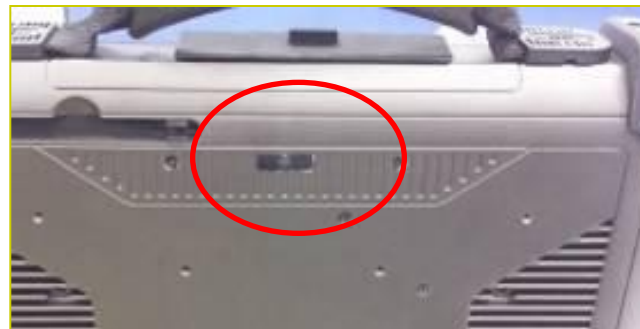

Software Utility- HotTab

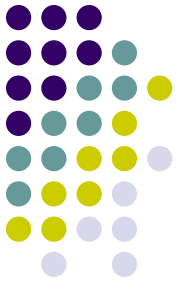

- **CONFIG: Configuration mode for customer to set the default working modes.**
 - Extreme Performance
 - High Performance
 - Office / Document
 - Power Saving

■ Hot Tab



Strict Environment Tests

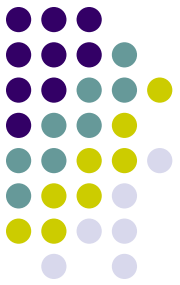

■ MIL standard – MIL-STD- 810F

1. Temperature: MIL-810F Std, M501.4 High Temp./ 502.4 Low Temp.
2. Shock: MIL-810F Std, M516.5
3. Vibration: MIL-810F Std, M514.5
4. Drop: 4 ft, free to Concrete, MIL-810F Std M516.5



■ Medical Certification

1. UL60601 Medical Equipment Certification

2. Two Models: R10V28T-RTU1, R08IA8T-RTU1
3. Exclusive Patent Number: E325705-A1-UL-1
4. Battery pack: UL 60950-1, Patent No: E213998-A15-UL-1



■ IP54



■ Sunlight Readable touch (Optional)



Features – Hot-swap Battery Pack

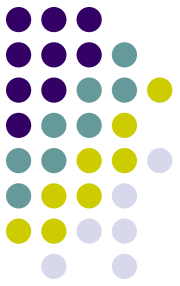

- External back-up battery pack supports quick swap in 1 minute.
- 2600mAh, 11.1V Battery can extend half of original operating time.
- Easy of change by two adjustable screws.

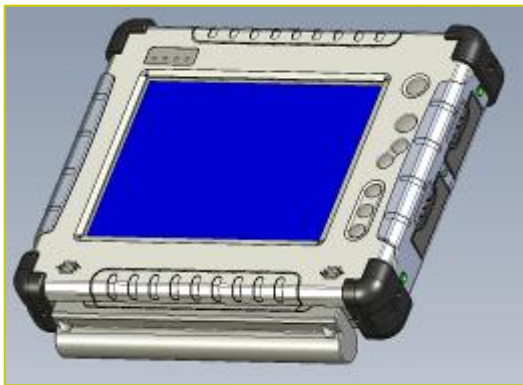

Outlook w/ system

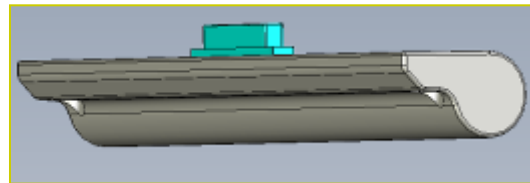

Easy carry of single pack

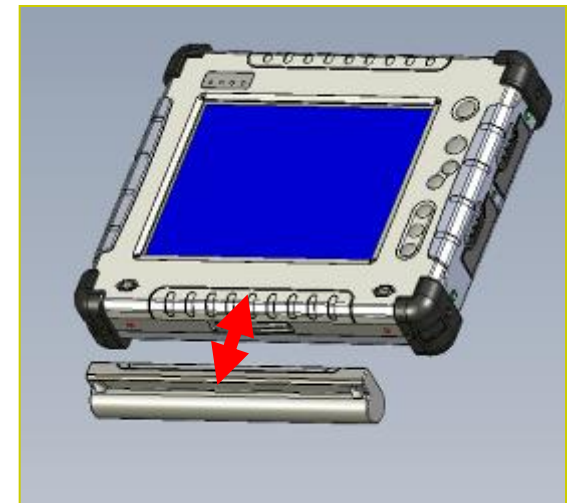

Easy and quick swap

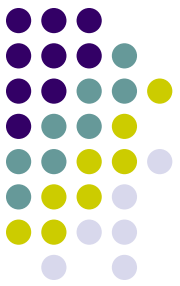

Features – Long-running Battery Hours

RELATIVE PERFORMANCE	Winmate I880	Winmate I980	Winmate IA80	Winmate V280
CPU	Intel Core 2 Duo U7500	Intel Atom Z530P	Intel Atom N270	VIA C7M
CPU Speed	1.06GHz	1.6GHz	1.6GHz	1.2GHz
CPU Thermal Design Power	10.0 watts	2.3 watts	2.5 watts	5.0 watts
CPU Mark	338.4	328.7	162.7	137.3
2D Graphics Mark	297.2	187.9	212.3	174.0
Memory Mark	238.5	209.1	224.0	124.1
Disk Mark	390.3	151.1	382.5	305.1
3D Graphics Mark	91.2	38.5	81.3	38.8
Overall PassMark	264.6	194.1	200.2	149.4
Observed Power Draw	13.60 watts	7.24 watts	12.80 watts	10.50 watts
Projected Battery Life	3.90 hours	7.35 hours	4.16 hours	5.05 hours

Use Hot-swap BTR can support continuous job for additional 2~4 hours.

Features –

Optional Sunlight Readable Touch

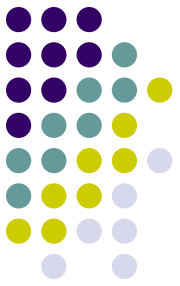

Sunlight Readable Touch Coating technology

- Compare to normal display, our sunlight readable touch is still viewable under strong sunlight

Winmate Sunlight
Readable Tablet PC

Other brand



Increasing Convenience – Default Accessory

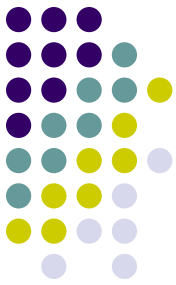

User manual CD		Battery	
XPe Recovery CD		Adapter	
User Manual		Slim Carry Bag	
Stylus Pen			

Attention:









Hand-Strap comes with tablet PC



- Above accessory are for standard Models of Winmate's Rugged Tablet PC without additional customized function.
- Default Recovery CD is for XPe. If there's no OS in Tablet, no this item attached. For other custom OS, we would provide different Recovery CD. Winmate will reserves right in changing or updating any version of OS and Software utility.
- User Manual CD had Driver, Utility and .pdf file of User Manual inside.
- A Stylus Pen, battery, AC power adapter, Slim Carry Bag are also standard parts unless any deduction in advance.



Accessories (Optional)

Vehicle Mounting Kit		Multi-function Vehicle Mounting Kit	
Carrying Handle		Multi-function Docking station	
Handstrip		Shoulder Strap	
Car power charger		Carry Bag	

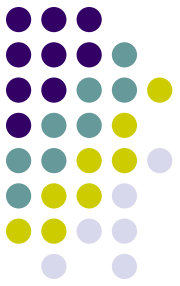

Optional I/O Solutions (Customized)

Type 1

VGA In/Out, RS232/422/485

- 10.4" and 12.1"
- Right hand I/O: VGA In/Out, RS232/422/485
- Left hand I/O: LAN, Audio, USB, Power Input



Type 2

VGA In/Out, CAN Bus

- 10.4" and 12.1"
- Right hand I/O: VGA In/Out, CAN Bus
- Left hand I/O: LAN, Audio, USB, Power Input



Accessories- Special Recommendation

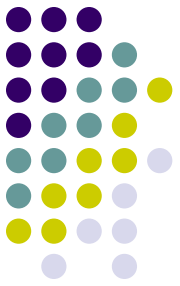

Vehicle Mounting Docking

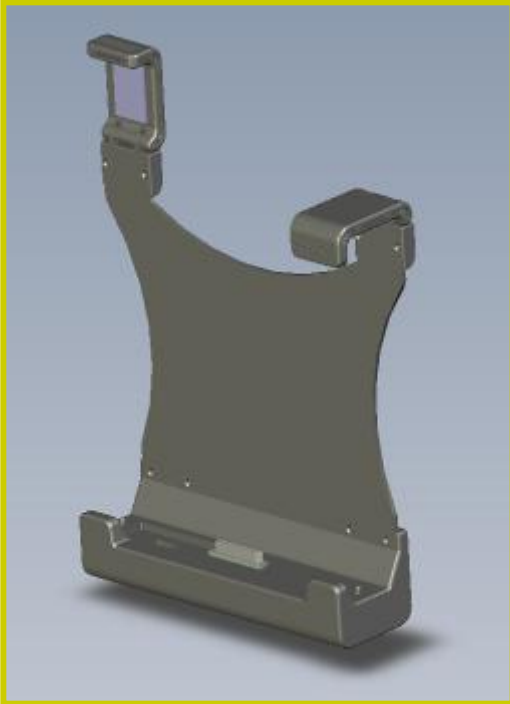

Outlook for VMD.

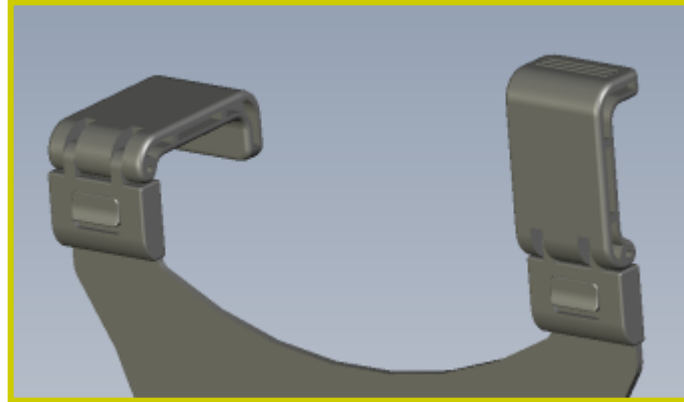

Ergonomic & User-friendly design of hooking the tablet pc

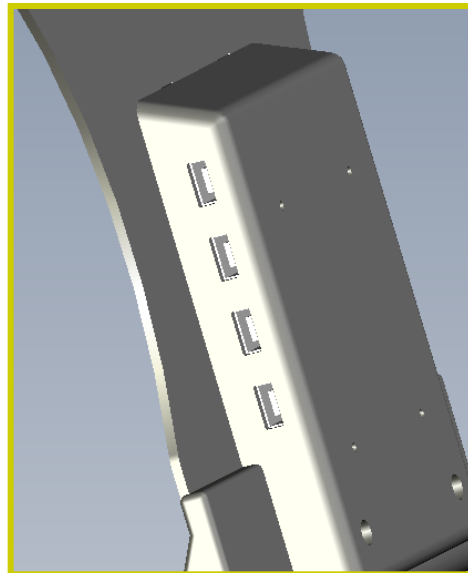

Expansion Slot for Vehicle User

- 8.4": 4x USB2.0, 1x LAN, 1x VGA
- 10.4"/12.1": 4x USB2.0, 1x RS232

Easy assembly w/ RAM mount kit on vehicles

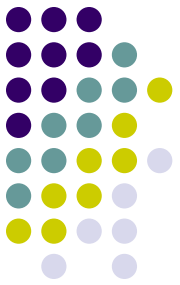

Convenient Vehicle Mounting Kit



Step1



Step2



Step3



Finished

- Multi-functional vehicle mount kit with car charger
- Power Input: 9~36V DC from car cigarette charging
- Output: 19V with a cable connecting with Rugged Tablet PC
- Mechanical mount: VESA, RAM mount RAM mount

RAM-Mount Kit



Multi-functional Desktop Docking Station

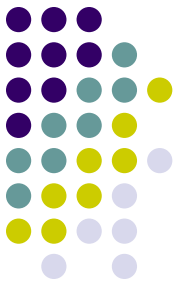

Easy Charger

- Standalone Power Charger
- LED Indicator for charging status

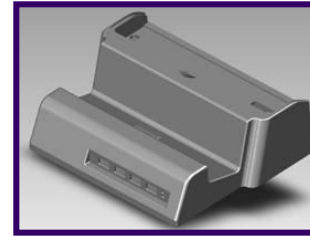

8.4" Docking

- 1x RJ-45 LAN
- 1x VGA output
- 4x USB2.0 (front)
- Docking Power input



10.4" 12.1" Docking

- 4x USB2.0 (front)
- Docking Power input

THANK YOU

Time for Q&A

